

INTEGRAR

Climatização Ltda.

© 2024 Integrar Climatização
Todos os direitos reservados.

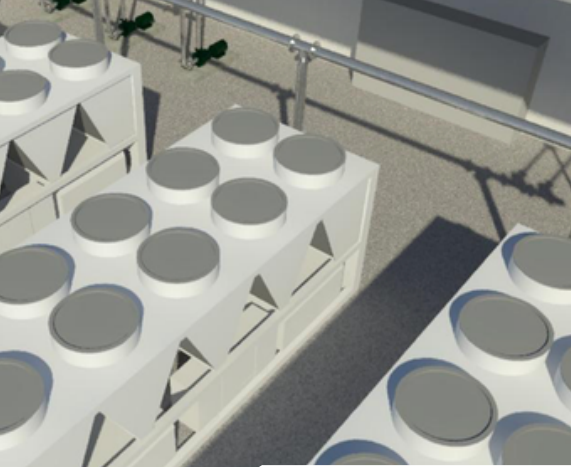

INTEGRAR

Climatização Ltda.

Desde 1999 trazendo novidades e tecnologias de ponta para nossos serviços e projetos de climatização.

O principal benefício que a Integrar oferece é o acesso a uma equipe altamente qualificada e experiente. Nossos colaboradores são especialistas no campo da climatização e possuem um profundo conhecimento técnico para projetar e implementar sistemas eficientes e personalizados. Ao escolher nossa empresa, o público-alvo pode confiar na expertise e habilidades dos nossos colaboradores para oferecer soluções de climatização de alta qualidade, que atendam às suas necessidades específicas. Além disso, nossa equipe está comprometida em fornecer um excelente atendimento ao cliente, garantindo um serviço profissional, pontual e eficaz. Ao trabalhar conosco, o nosso cliente pode contar com uma equipe dedicada e capacitada, que se esforça para superar expectativas e oferecer resultados excepcionais.

Buscamos a excelência em todos os aspectos do nosso trabalho, mantendo altos padrões de qualidade, precisão e inovação. Agimos com integridade, ética e transparência em todas as nossas relações, priorizando a confiança e o respeito mútuo. Estimulamos a criatividade e a busca constante por soluções inovadoras.

Valorizamos a colaboração e o trabalho em equipe, promovendo um ambiente inclusivo onde as ideias são compartilhadas e a diversidade é valorizada. Assim como, a colaboração e o trabalho em equipe, promovendo um ambiente inclusivo onde as ideias são compartilhadas e a diversidade é valorizada.



INTEGRAR

Climatização Ltda.

Desde 1999 trazendo novidades e tecnologias de ponta para nossos serviços e projetos de climatização.

A Integrar destaca-se por proporcionar um acesso exclusivo a uma equipe altamente capacitada e especializada. Nossos colaboradores são peritos na engenharia da climatização, possuindo um conhecimento técnico e uma vasta experiência que os capacita a conceber e implementar sistemas personalizados e altamente eficientes, utilizando as mais avançadas tecnologias, incluindo a metodologia Building Information Modeling (BIM), onde orgulhosamente somos pioneiros no mercado. Optando por nossa empresa, o público-alvo pode depositar total confiança na expertise de nossa equipe, garantindo soluções de climatização da mais alta qualidade.

Além disso, comprometemo-nos a oferecer um atendimento de excelência ao cliente, assegurando um serviço profissional, pontual e eficaz. Ao optar por trabalhar conosco, nossos clientes podem contar com uma equipe dedicada e empenhada em superar expectativas e proporcionar resultados verdadeiramente excepcionais.

Pautamos nossa atuação na integridade, ética e transparência em todas as relações, priorizando a construção de confiança e o respeito mútuo. Incentivamos a criatividade e a constante busca por soluções inovadoras, fomentando uma cultura de colaboração e trabalho em equipe. Valorizamos a diversidade, promovendo um ambiente inclusivo onde as ideias são compartilhadas e celebramos a riqueza da variedade de perspectivas



1.253

Projetos Concluídos

18

Premiações

+24

Anos de Mercado

Há mais de 20 anos criando ambientes confortáveis e saudáveis por meio de sistemas de climatização eficientes, que promovam o bem-estar, a produtividade e a sustentabilidade.



Nossos Serviços

MODELAGEM BIM

PROJETOS 2D e 3D

CERTIFICADO LEED

Soluções de engenharia inovadoras e de alta qualidade em AVAC-R para atender às necessidades dos nossos clientes, promovendo o desenvolvimento sustentável e o progresso tecnológico.

Nossos Clientes



MOZAK



Tegra East Side

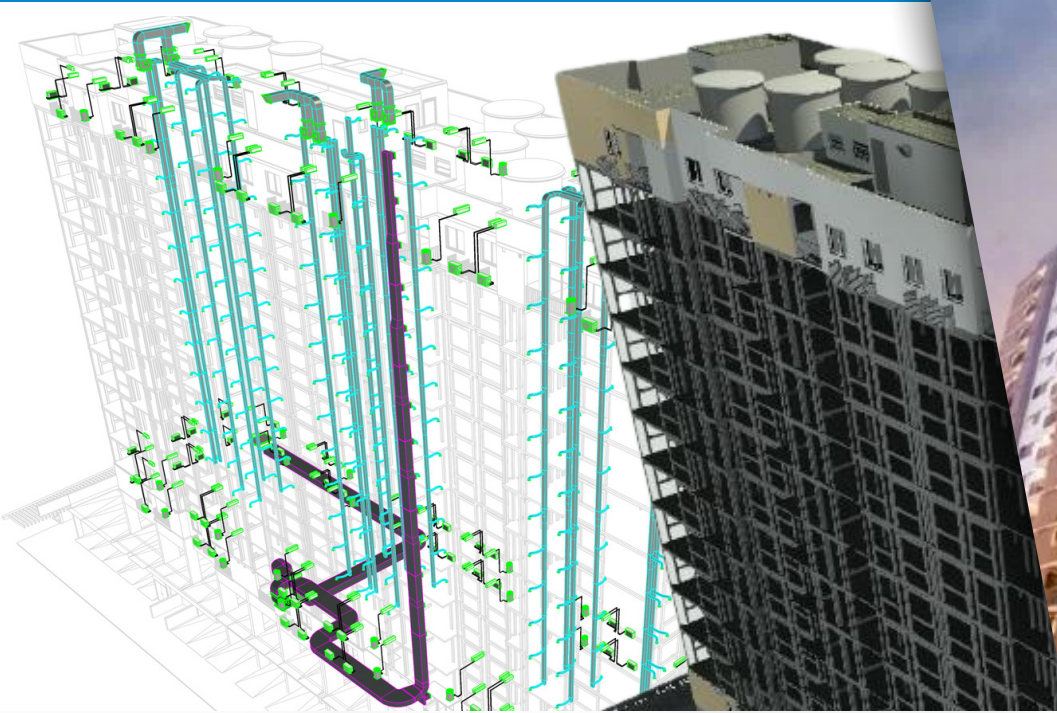

Opportunity Homem de Mello

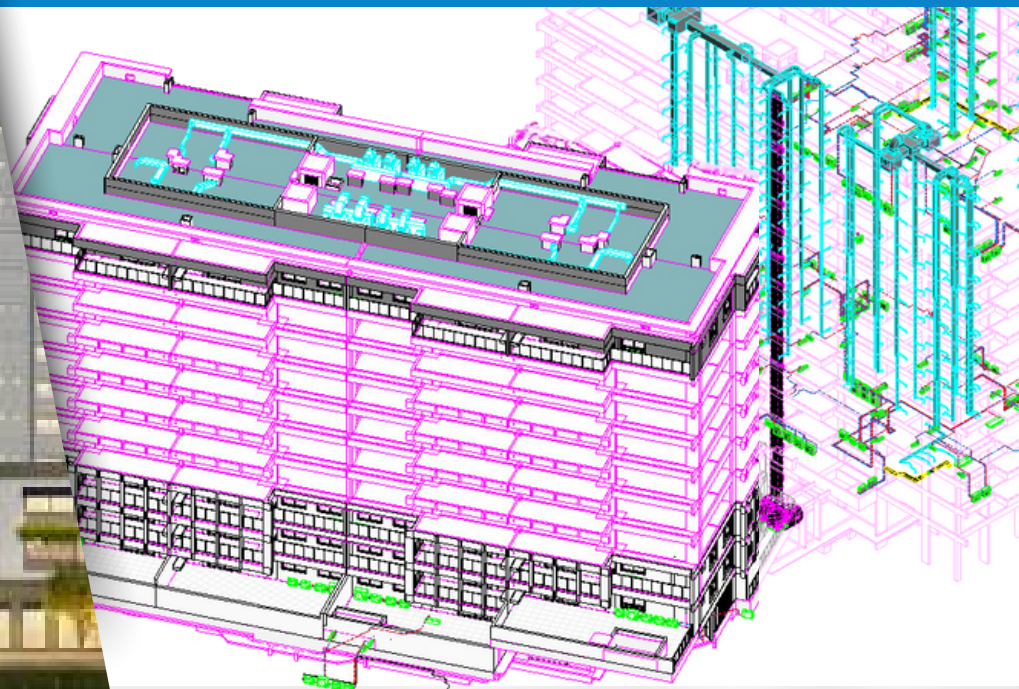

Cyrela Reserva Uno



Cyrela Reserva Golf

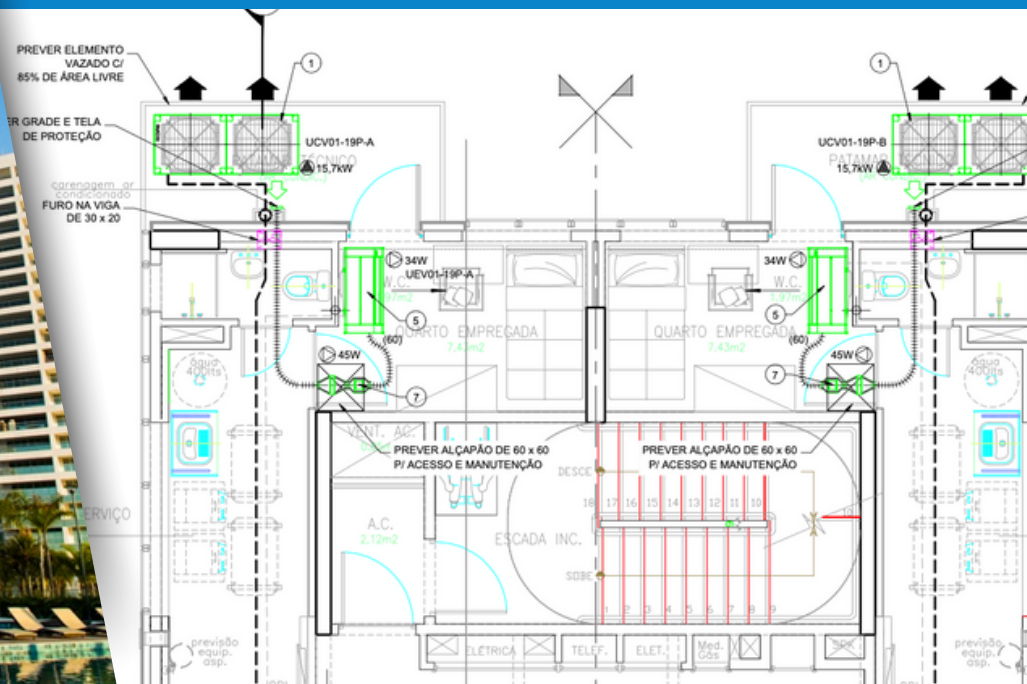

Edifícios Residenciais de Alto Padrão

SIG - Gloria Residencial

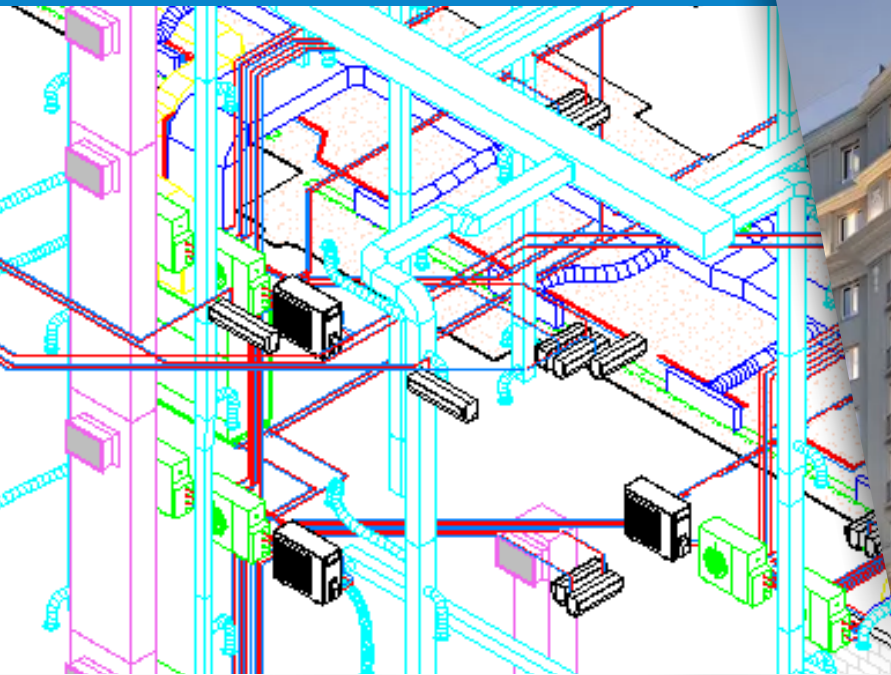

Gafisa Cyano Residencial

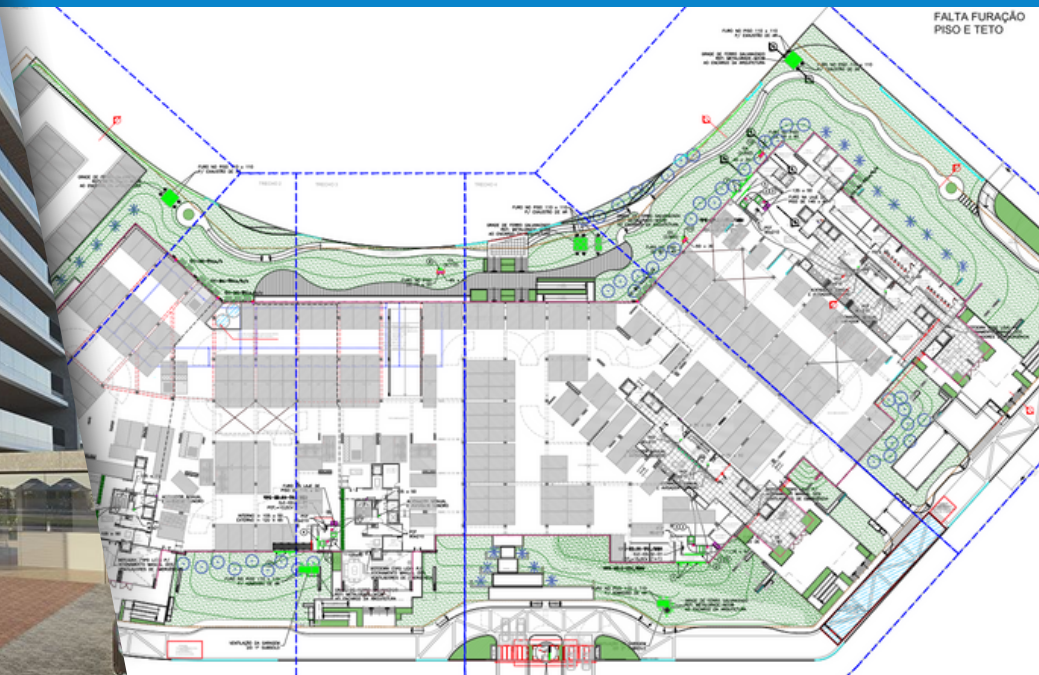

CEO - Corporate Executive Office

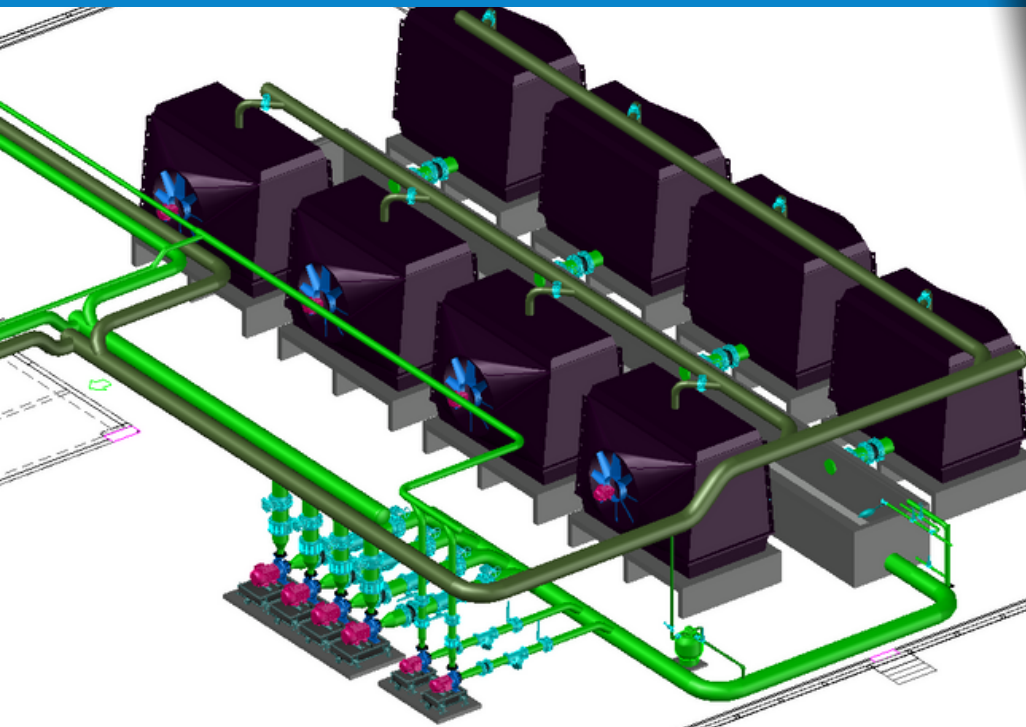

Dimensions Office Park

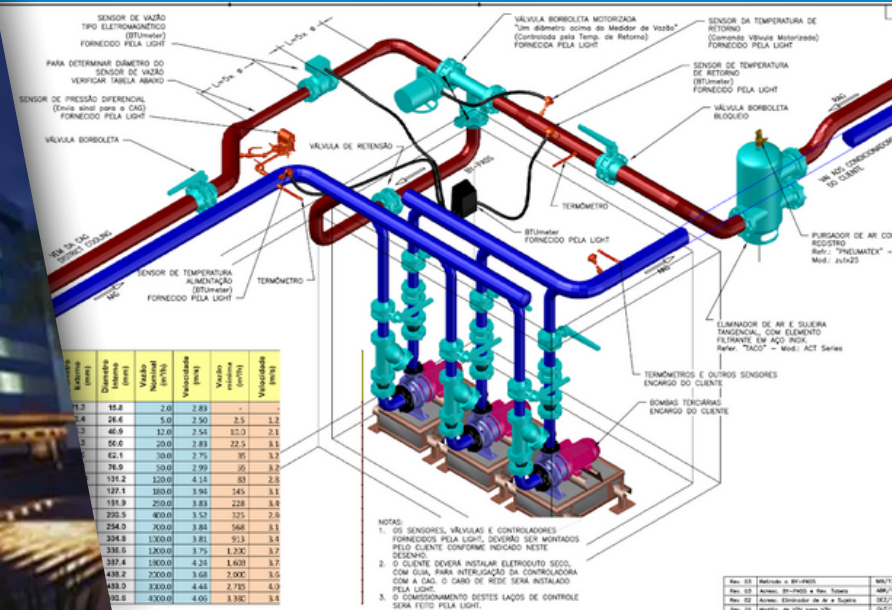

AR CONDICIONADO
DETALHE DE INSTALAÇÃO DOS BTUmeters
CONJUNTO DE MONTAGEM

INTEGRAR Climatização Ltda. Rua de Minas, 81 - 10 de Setembro - Belo Horizonte, MG - (Elemento Filtrante em Aço Inox - Marca: "TACO" - Mod. ACT Series)

ESCALA 1:100 Nº DESENHO 745/AB-01 REVISÃO 17-01

Centro Metropolitano

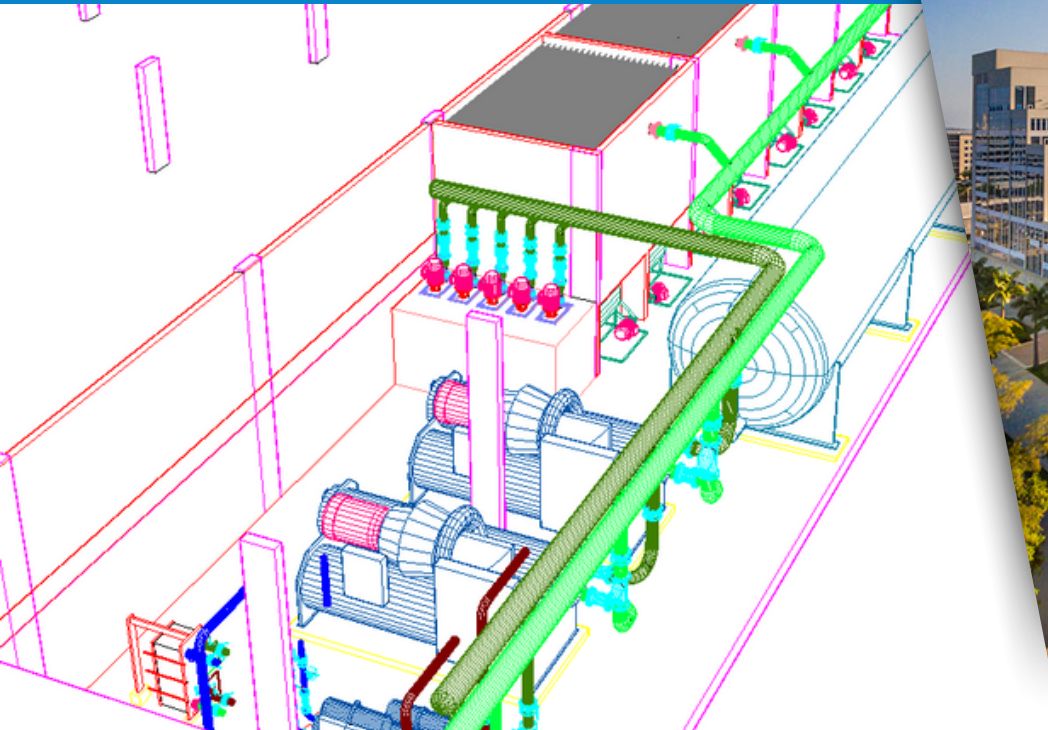

Multiplan Vila Hípica

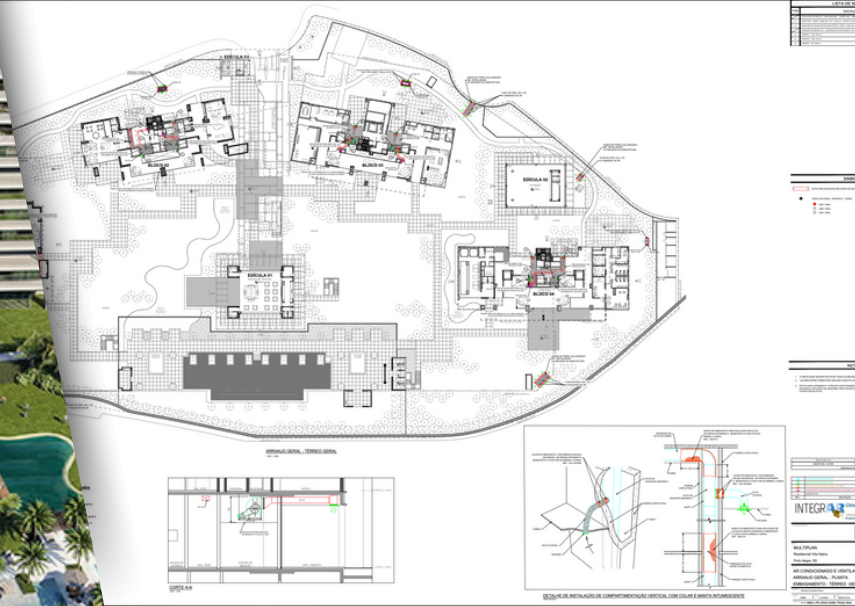

Hospital Quinta D'or

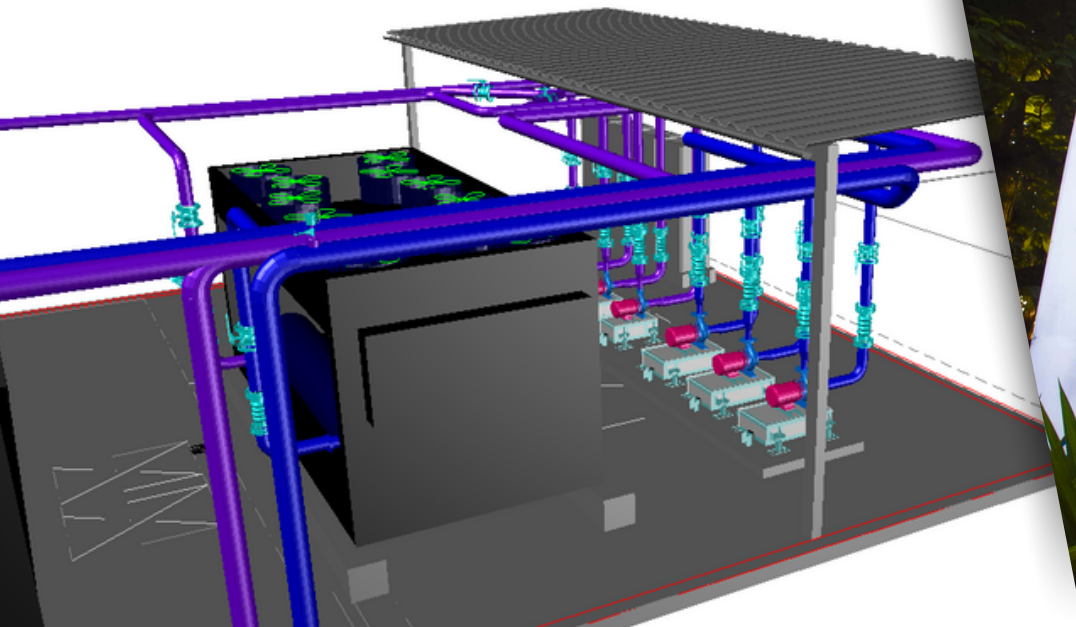

Hospital Copa D'or

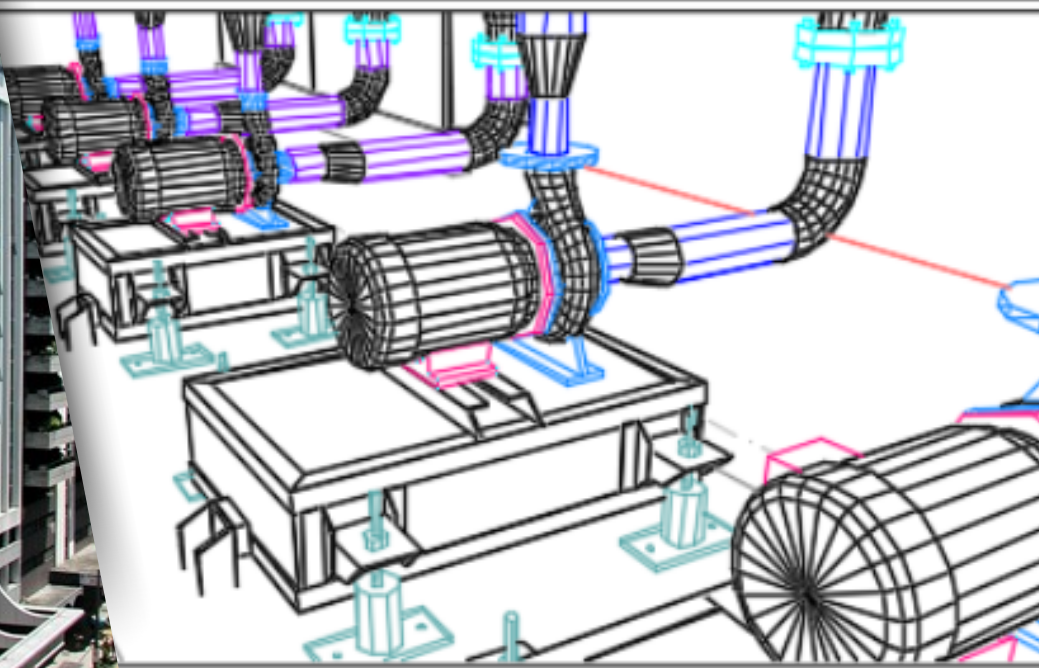

Aeroporto de Goiânia

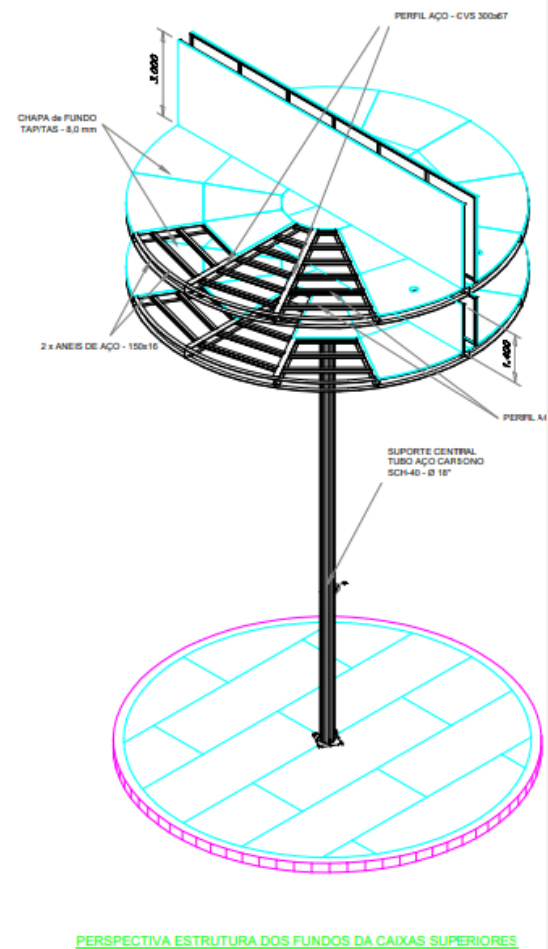
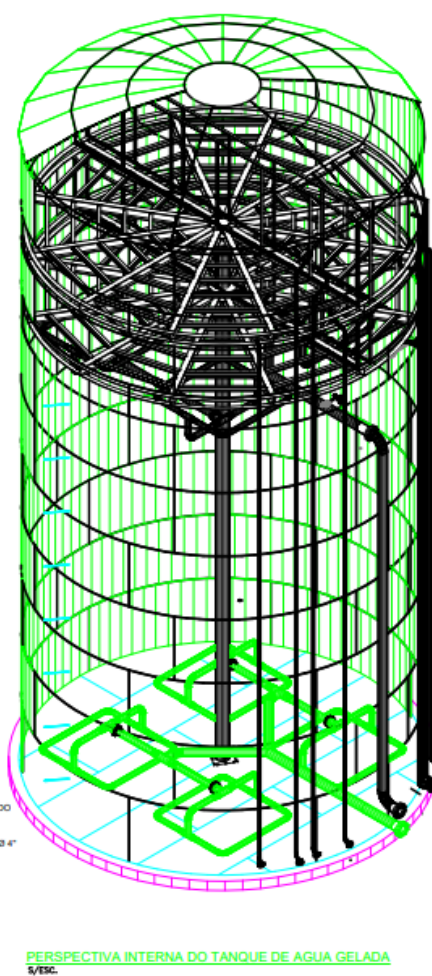
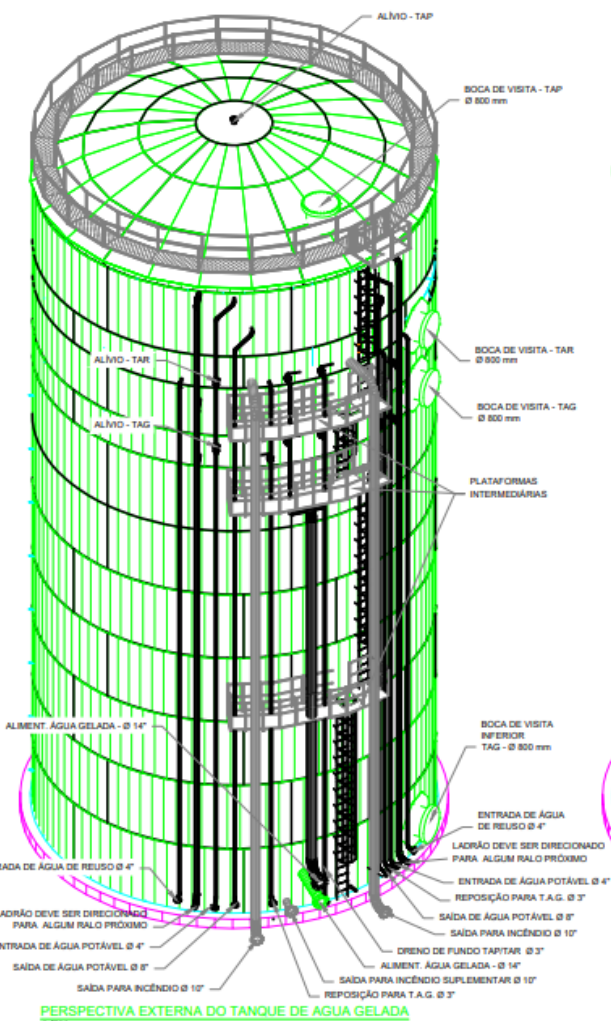
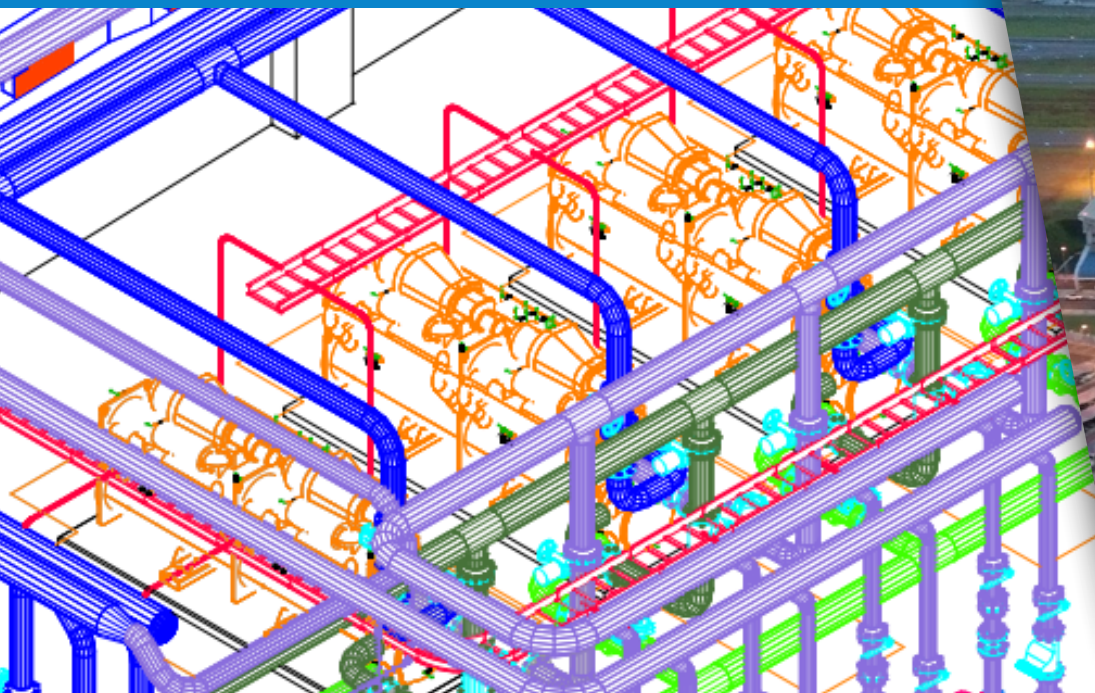

Museu Nacional

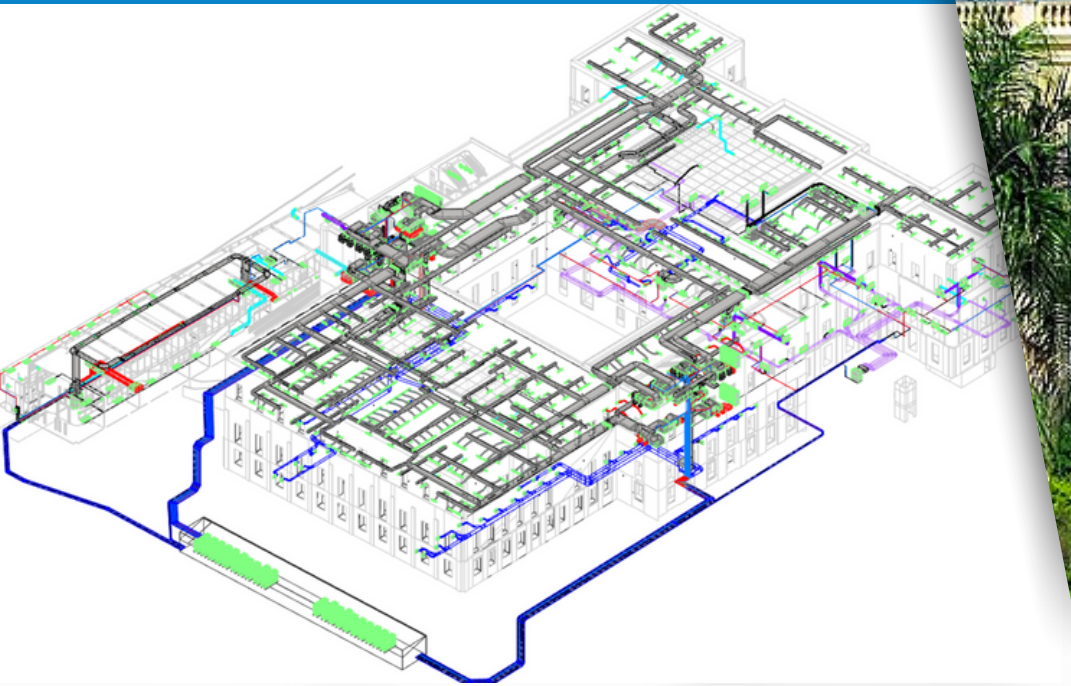

Teatro Municipal

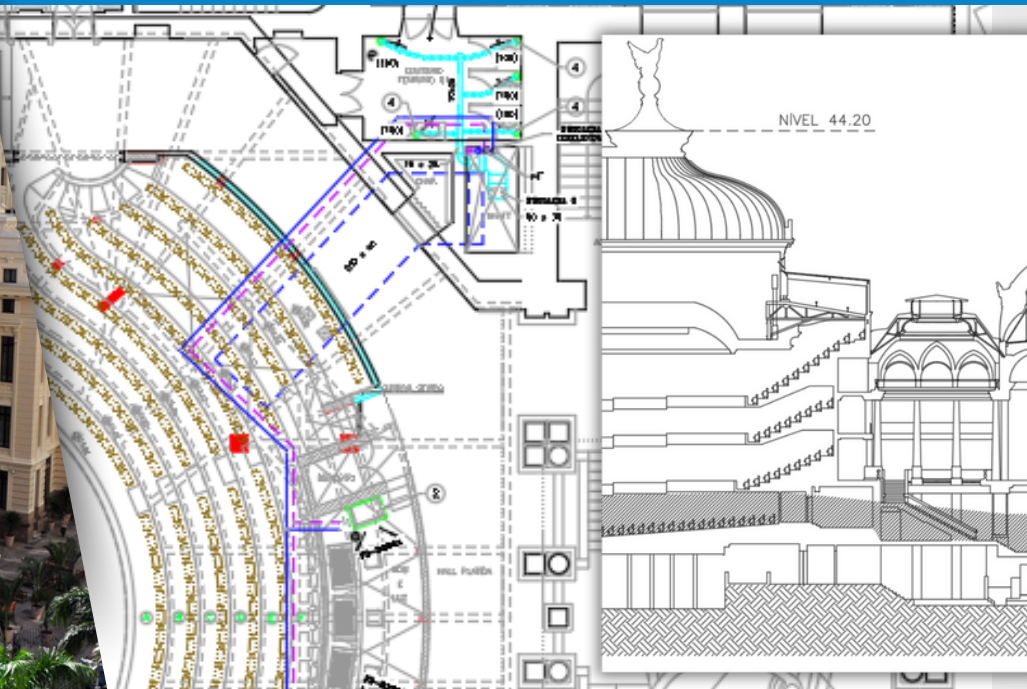

Industria Michelin

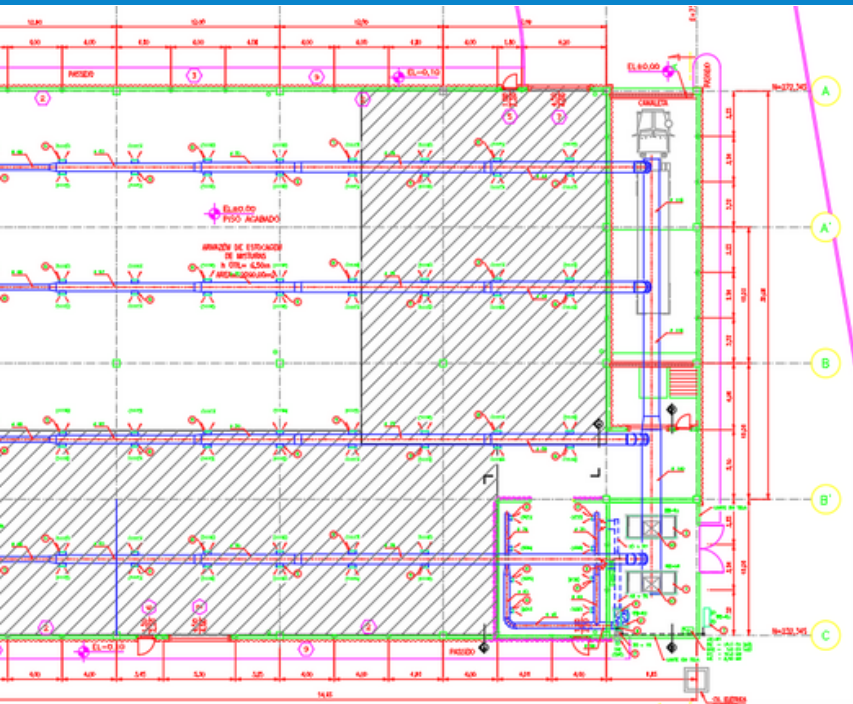

Industria Garoto

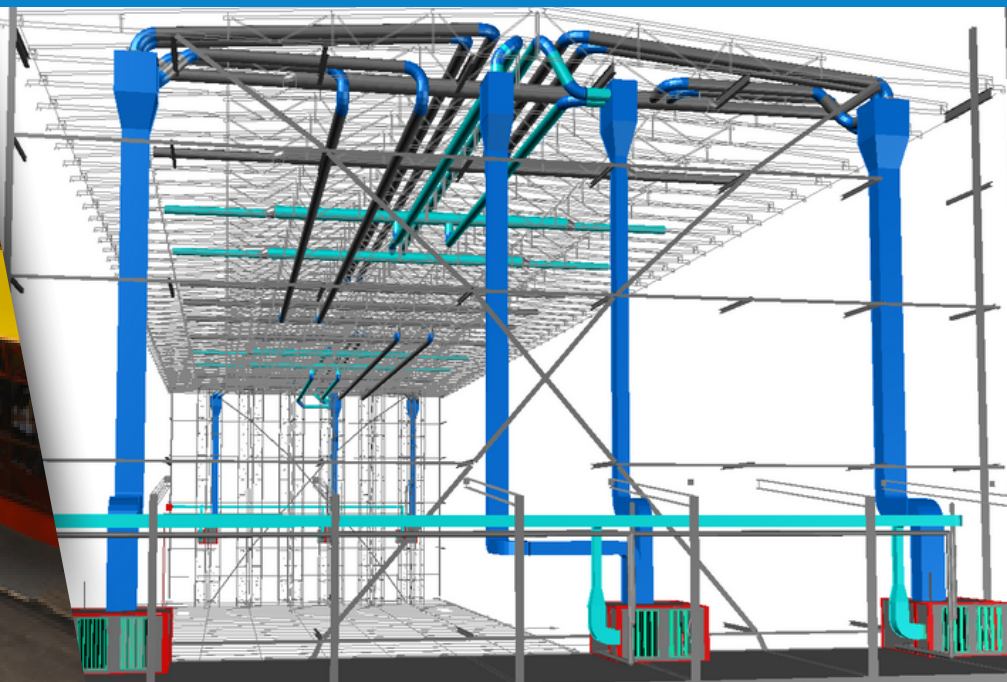

Fiocruz Castelo Mourisco

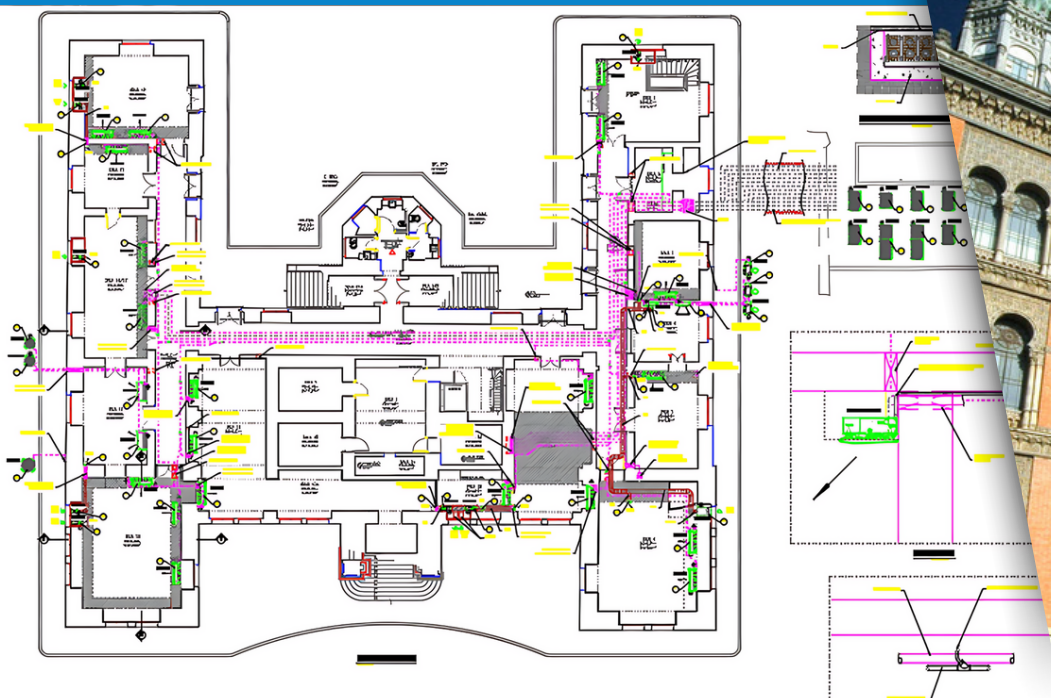

Laboratório Merck

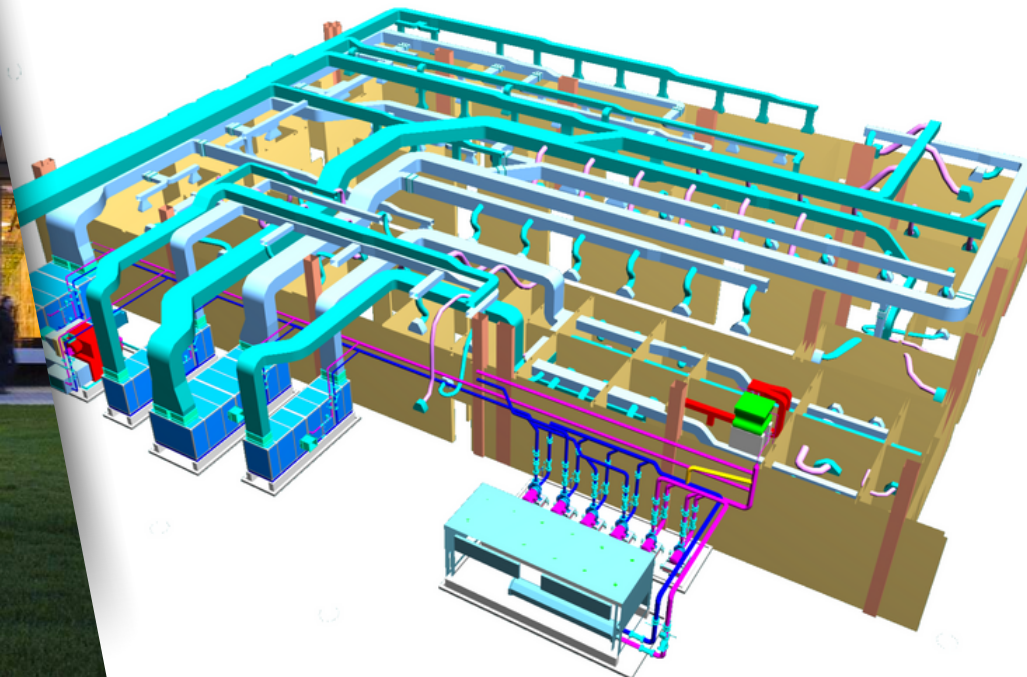

Ministério da Fazenda

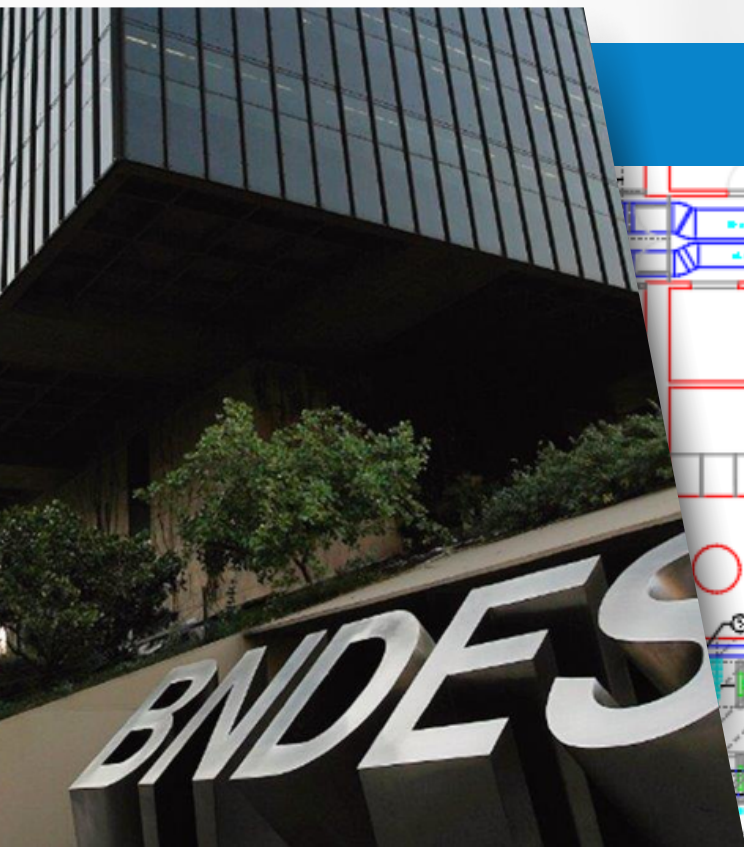
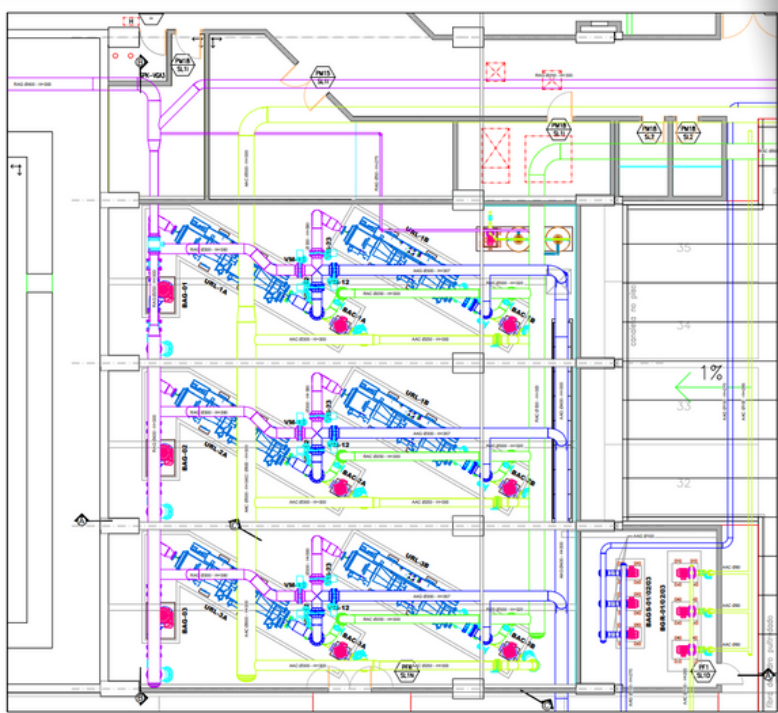

BNDES

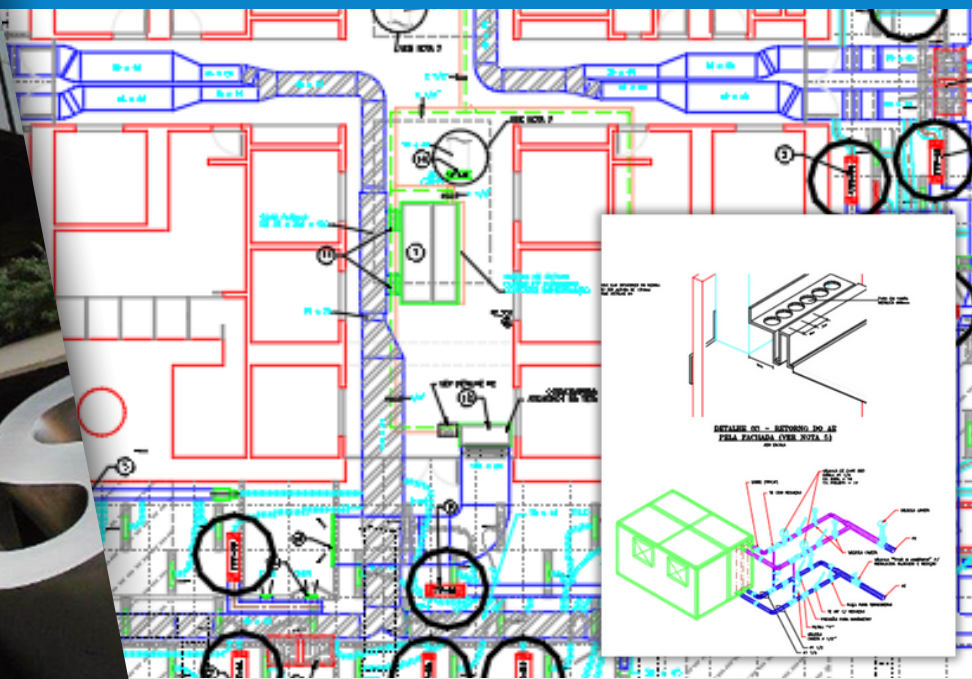

Rio Design Barra

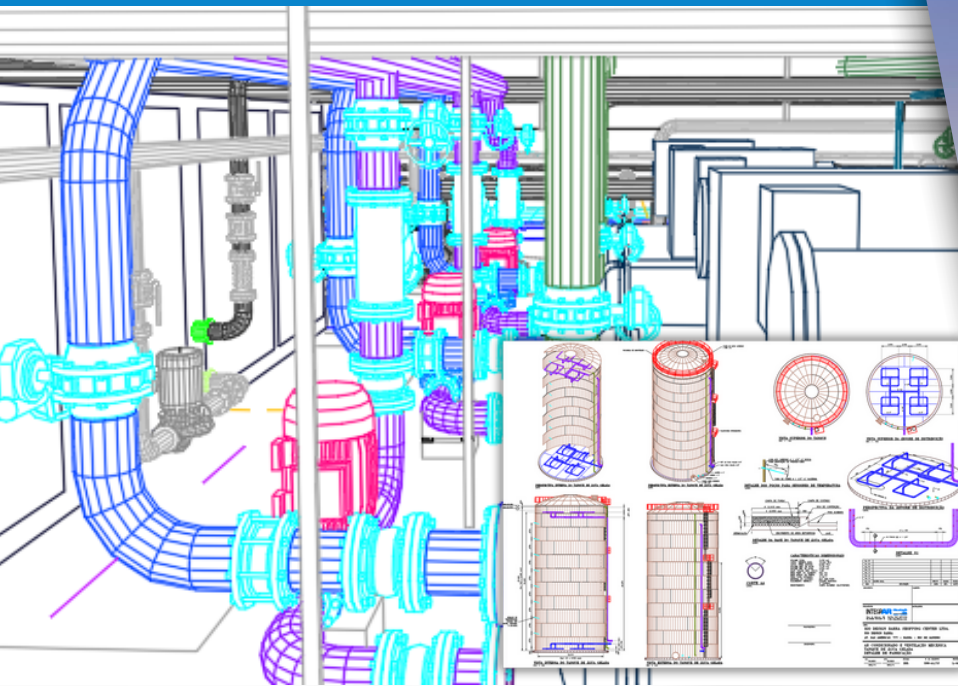

Porto Velho Shopping

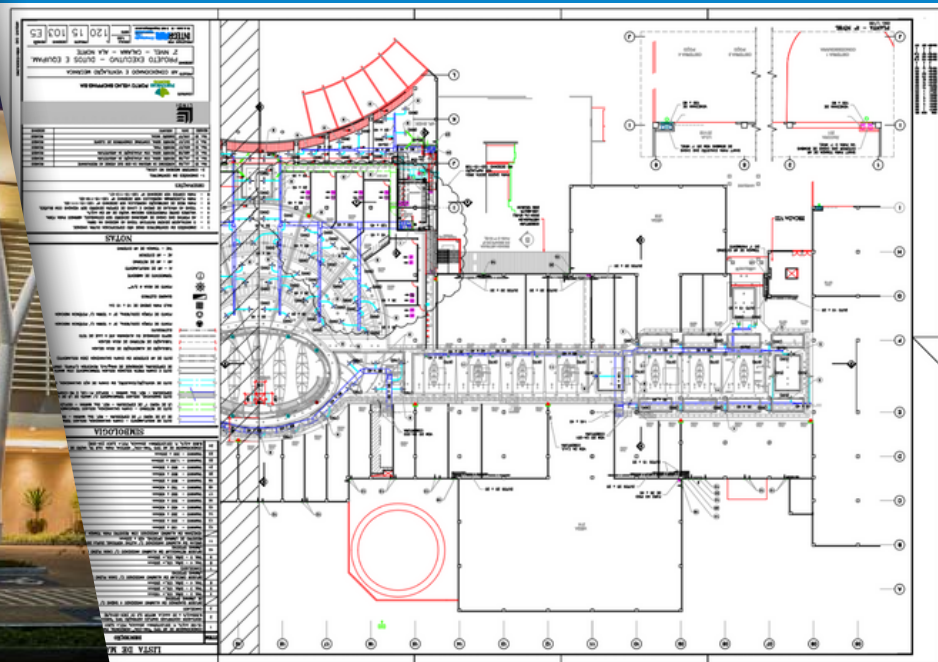
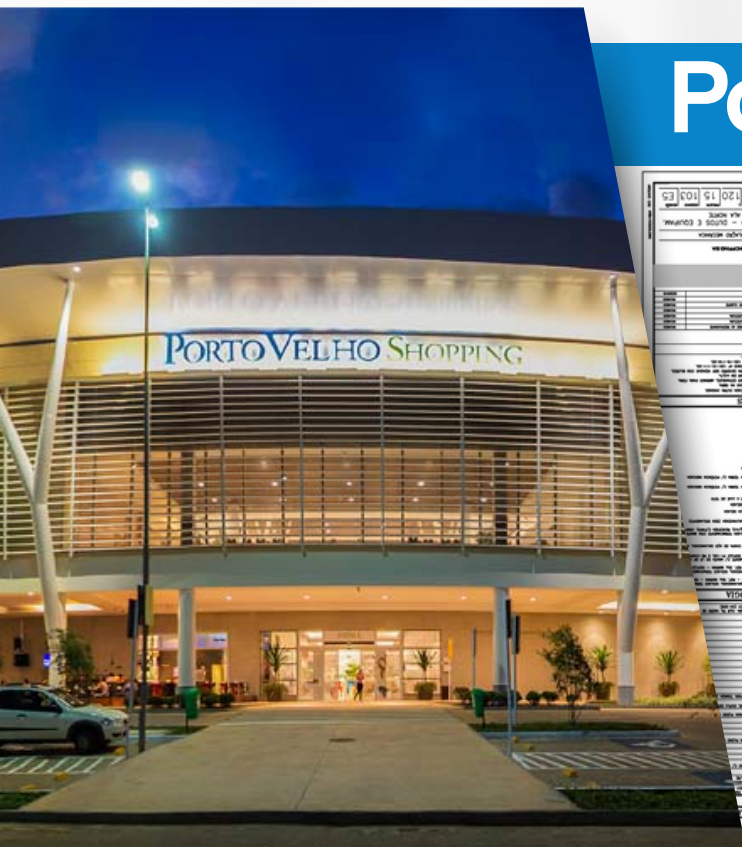

Copacabana Palace

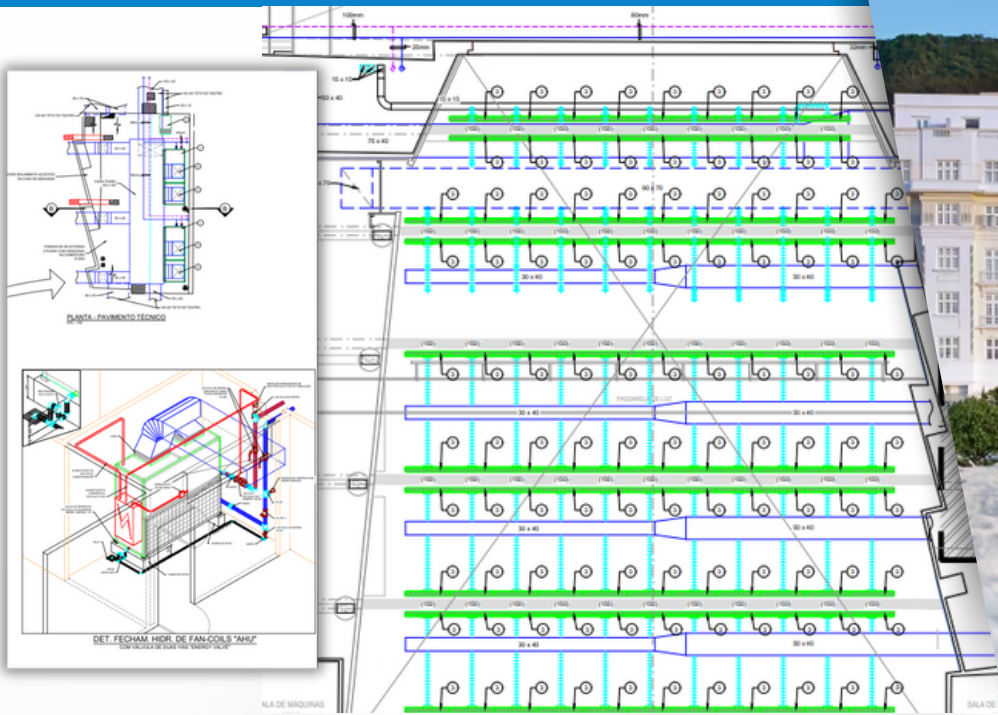

Grand Hyatt Hotel

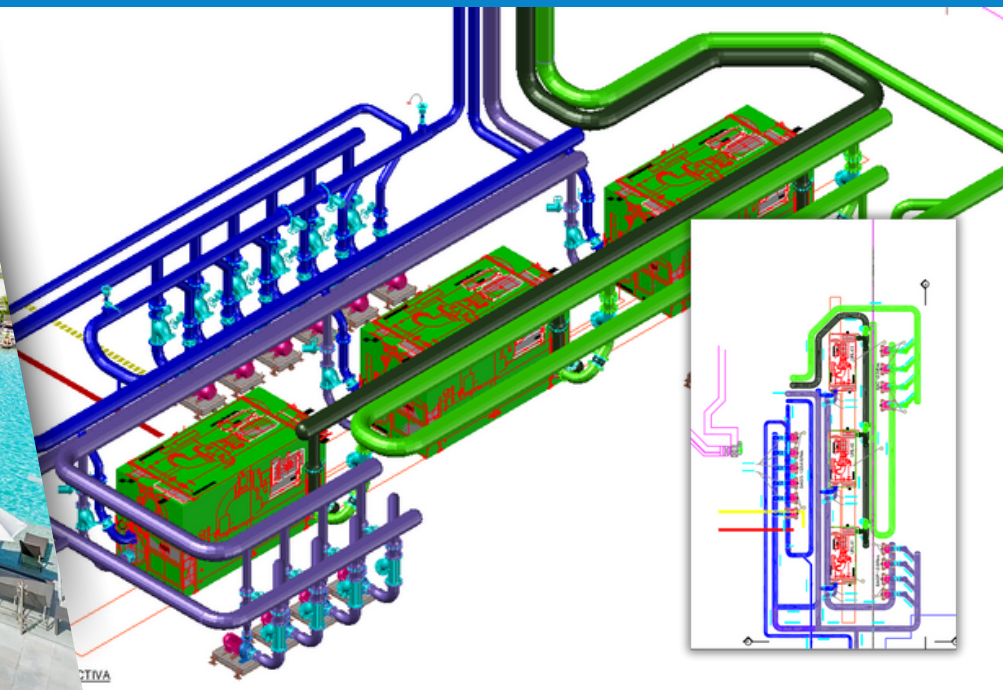



LEI Nº 5.194, DE 24 DE DEZEMBRO DE 1966. Regula o exercício das profissões de Engenheiro, Arquiteto e Engenheiro-Agrônomo.



“A PROFISSÃO É BEM SOCIAL DA HUMANIDADE E O PROFISSIONAL É O AGENTE CAPAZ DE EXERCÊ-LA, TENDO COMO OBJETIVOS MAIORES A PRESERVAÇÃO E O DESENVOLVIMENTO HARMÔNICO DO SER HUMANO, DE SEU AMBIENTE E DE SEUS VALORES.”

FONTE: ART. 8º DO CÓDIGO DE ÉTICA PROFISSIONAL.

INTEGRAR

Climatização Ltda.

CLIQUE E SEJA REDIRECIONADO:

 integrar@integrar.com.br

 [@integrar_climatizacao](https://www.instagram.com/integrar_climatizacao)

 (21) 2273-6144

 www.integrar.com.br

ALGUMA DÚVIDA?



Aponte sua camera ao
QR CODE
e acesse nosso site
WWW.INTEGRAR.COM.BR

